

fertilpot

LE POT PLANTABLE

100% NATUREL

fertil

T: +33 (0)1 46 04 41 24 ● F: +33 (0)1 47 12 08 18 ● E: adv@fertil.fr ● www.fertil.fr

Catalogue



Présentation

Le FERTILPOT est un godet de culture biodégradable **en fibres de bois**. Il s'emploie en horticulture, en pépinière ornementale, viticole ou forestière, comme en maraîchage.

Sa **pénétrabilité par l'eau, par l'air et par les racines** est exceptionnelle. Cette propriété, allée à sa bonne résistance mécanique, ont fait la réputation et le succès du FERTILPOT à travers le monde. FERTILPOT s'adresse à tous les utilisateurs qui recherchent une culture plus rapide, un excellent système racinaire et une reprise sans choc de transplantation.

C'est également une réponse originale aux besoins exprimés par les utilisateurs qui recherchent **des produits "prêts à planter" respectueux de l'environnement**.

FERTILPOT en quelques mots:

<ul style="list-style-type: none">✓ « Plantable » : la plante se met en terre avec son pot.✓ Naturel : du bois, rien que du bois!✓ Approvisionnement local (bois certifié PEFC)✓ Utilisable en Agriculture Biologique (selon RCE 834/2007)	ECOLOGIE
<ul style="list-style-type: none">✓ Cernage aérien : pas d'effet chignonage, stimulation de la croissance des racines secondaires✓ Perméable à l'air, à l'eau, aux racines.	AGRONOMIE
<ul style="list-style-type: none">✓ Gain en production : rempotage plus rapide, densités de plantation réduites✓ Plus de stockage ni traitement des déchets plastique✓ Fabrication française, approvisionnement local des matières premières	ECONOMIE SOCIAL

Présentation

La gamme FERTILPOT est très étendue pour faire face à la diversité des situations

Le pot peut être rond, carré, carré jumelé ou carré en plaques ; avec ou sans ergots, avec colerettes ou rebords ; leurs dimensions varient entre 4 x 4 x 5 cm (35 cm³) et 17 x 16 cm (3 litres). Les pots peuvent être conditionnés avec une barquette ou un plateau (FERTILPACK).

Ci-dessous nos principaux modèles :

FERTILPOT NT



FERTILPOT traditionnel



Principales utilisations

	PRODUCTEUR EN AGRI. BIO	MARAICHER / HYDROPONIE	HORTICULTEUR	MUNICIPALITE	PEPINIERISTE	PEPINIERISTE VITICOLE	PARTICULIER
FERTILPOT ROND INDIVIDUEL (Ø X H EN CM)							
5 x 9	★★★	★			★★	★★★	
7 x 9 ; 7 x 7,5	★★★	★★		★	★★	★★★	
6 x 6 ; 8 x 8	★★★	★★	★★	★★★	★	★	★★★
10 x 10; 11 x 11 10 x 18; 18 x 16(3L)	★★★		★★★	★★★	★★★	★	
FERTILPOT CARRE INDIVIDUEL (L X H X EN CM)							
10x18 et 11x19	★★★			★★	★★		
FERTILPOT EN PLAQUE							
36 pots de 4x5 20 ou 30 pots de 5x5	★★★	★★★	★	★★	★		★★★
12 pots de 8x8	★★★	★★★	★★★	★★★	★		★★
FERTILPOT EN PLATEAU = FERTILPACK							
4,5x6,5 carré- 77 alvéoles	★★★	★			★★★		
7x9 rond- 32 alvéoles	★★★				★★	★★★	
FERTILPOT NT							
10,5-12	★★★		★★★	★★★			
14			★★★		★★★	★★	

Sommaire

FERTILPOT NT	p.6
FERTILPOT TRADITIONNEL	
Ronds individuels	p.7
Carrés individuels	p.11
Carrés individuels (HC)	p.13
En plaque	p.14
Le sciage	p.17
FERTILPOT EN PLATEAU	p.18

FERTILPOT NT

- **FERTILPOT BARQUETTE NT 1L**
- **1 000 cm³**

590.C : Carton de 450 barquettes
590.1 : Palette de 6950 barquettes

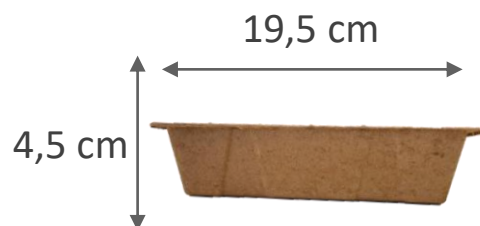

- **FERTILPOT NT10.5**
- **400 cm³**

591.C1: Carton de 800 pots
591.1: Palette de 13 200 pots



- **FERTILPOT NT12**
- **650 cm³**

592.C: Carton de 616 pots
592.1: Palette de 8 960 pots



- **FERTILPOT NT14**
- **1 000 cm³**

593.C: Carton de 484 pots
593.1: Palette de 6 300 pots

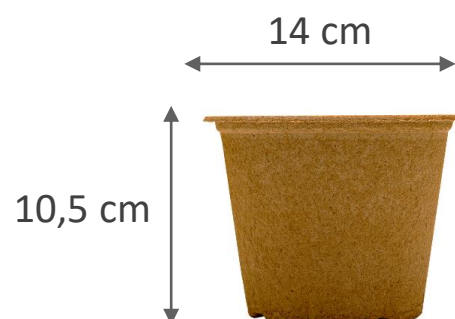

FERTILPOT TRADITIONNEL

Pots ronds individuels

- FERTILPOT 5,5x5

- 100 cm³

503.C: Carton de 3 240 pots

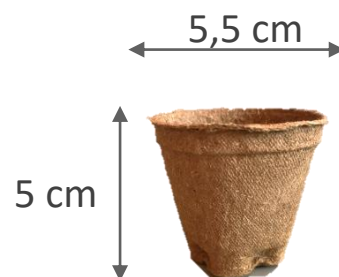

- FERTILPOT 4,5x7

- 75 cm³

500.C: Carton de 2 520 pots

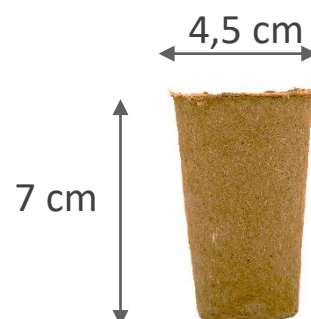

- FERTILPOT 5x9

- 110 cm³

501.C: Carton de 2 170 pots

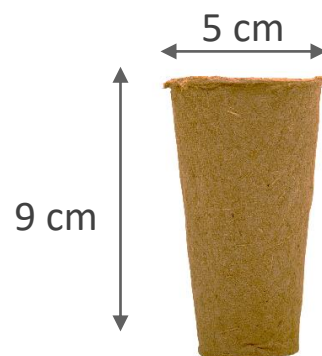

- FERTILPOT 6x6

- 110 cm³

504.C: Carton de 3 000 pots

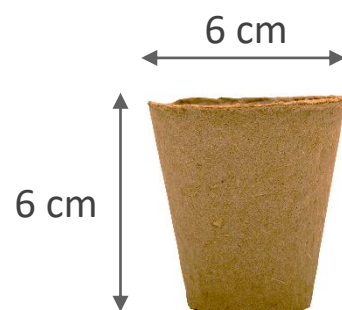

Pots ronds individuels

- **FERTILPOT 6x6 (ergots)**
- **110 cm³**

505.C-1: Carton de 2 520 pots

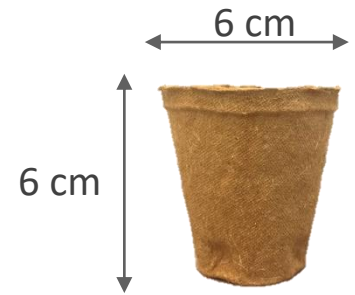

- **FERTILPOT 7x6 (ergots et colerette)**
- **110 cm³**

507.C: Carton de 1 750 pots

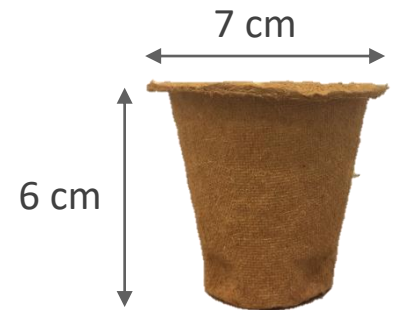

- **FERTILPOT 7x7,5 (ergots)**
- **200 cm³**

506.C: Carton de 1 370 pots

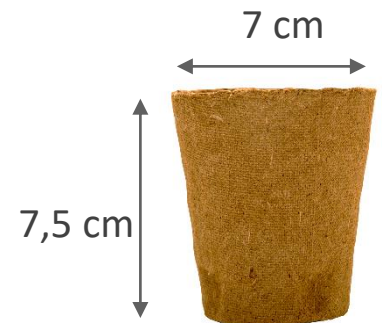

- **FERTILPOT 7x9 (ergots)**
- **240 cm³**

509.C: Carton de 1 280 pots

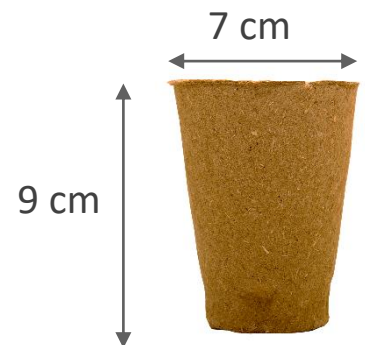

Pots ronds individuels

- **FERTILPOT 8x8**
- **320 cm³**

510.C: Carton de 1 370 pots



- **FERTILPOT 8x8 (ergots)**
- **320 cm³**

511.C: Carton de 1 100 pots

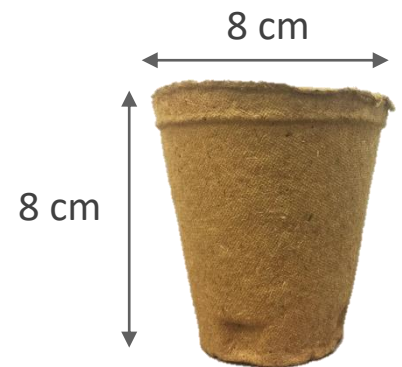

- **FERTILPOT 10x10**
- **510 cm³**

513.C: Carton de 810 pots

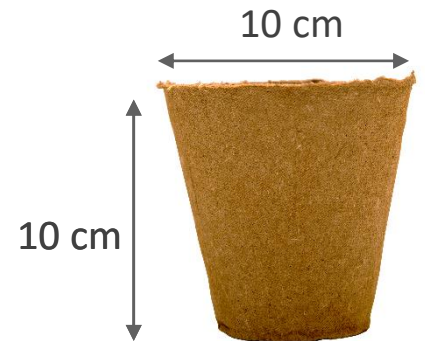

- **FERTILPOT 7x12**
- **246 cm³**

517.C: Carton de 792 pots



Pots ronds individuels

- **FERTILPOT 11x11**
- **800 cm³**

519.C: Carton de 480 pots



- **FERTILPOT 10x18**
- **800 cm³**

516.C: Carton de 480 pots

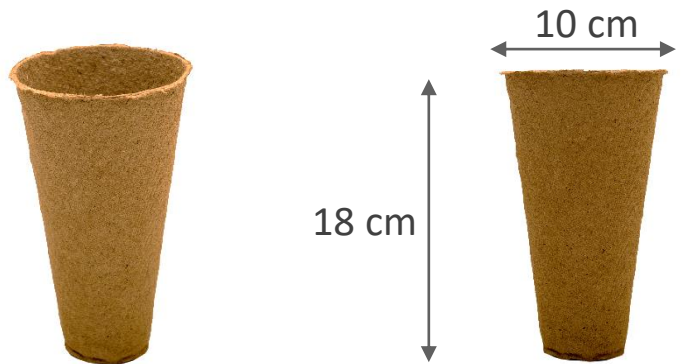

- **FERTILPOT 18x16**
- **3 000 cm³**

580.C: Carton de 84 pots
580.1: Palette de 1 316 pots

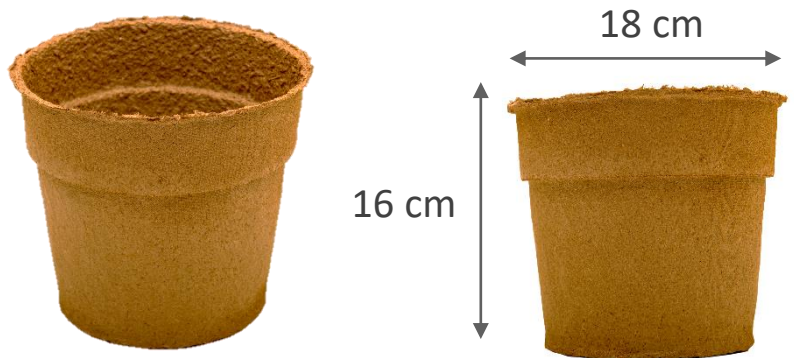

Pots carrés individuels

- **FERTILPOT 4,4x4,3**
- **30 cm³**

543.1C: Carton de 6 144 pots

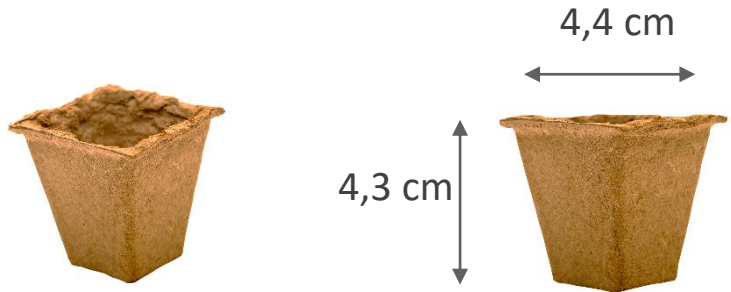

- **FERTILPOT 5x5**
- **90 cm³**

545.1C: Carton de 2 552 pots

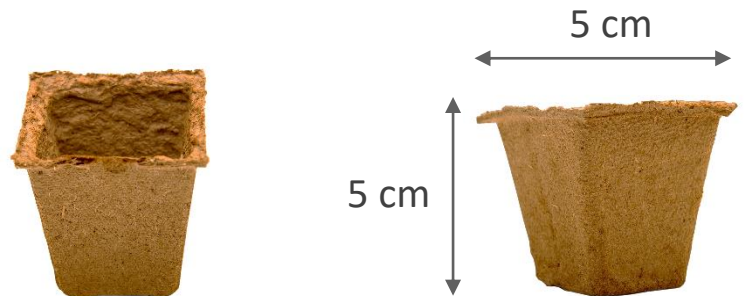

- **FERTILPOT 6x6**
- **110 cm³**

548.1C: Carton de 2 268 pots

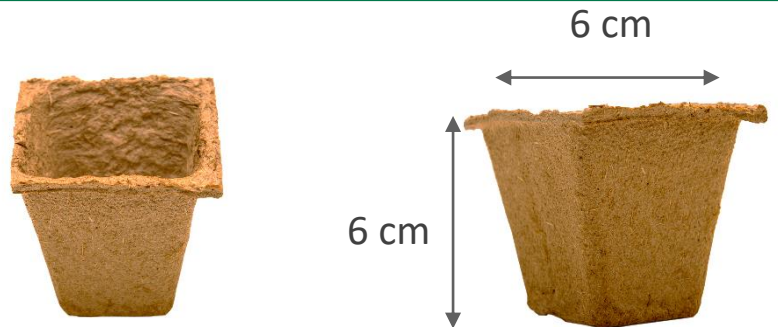

- **FERTILPOT 8x8**
- **300 cm³**

552.1C: Carton de 864 pots

552.01: Palette de 14 580 pots

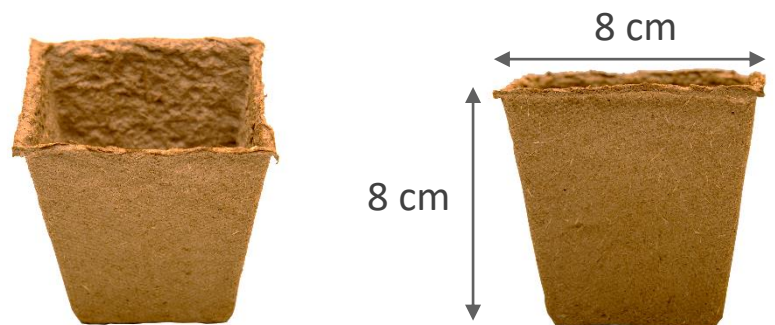

Pots carrés individuels

- **FERTILPOT 9x9**
- **500 cm³**

512.C: Carton de 740 pots

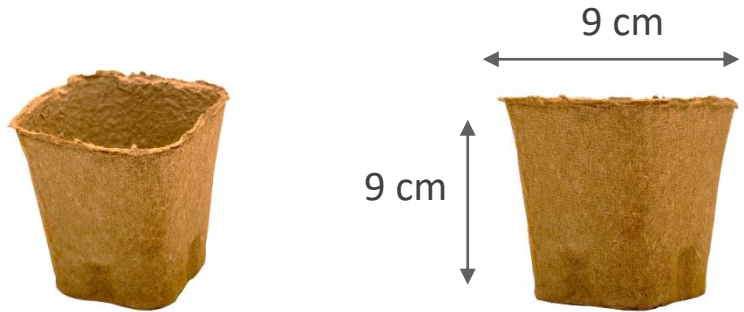

- **FERTILPOT 10x9**
- **500 cm³**

515.C: Carton de 416 pots

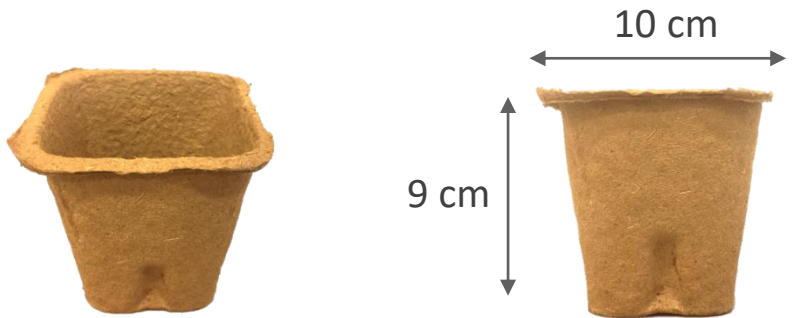

- **FERTILPOT 11x19**
- **1 600 cm³**

571.1C: Carton de 144 pots
571.01: Palette de 2 940 pots

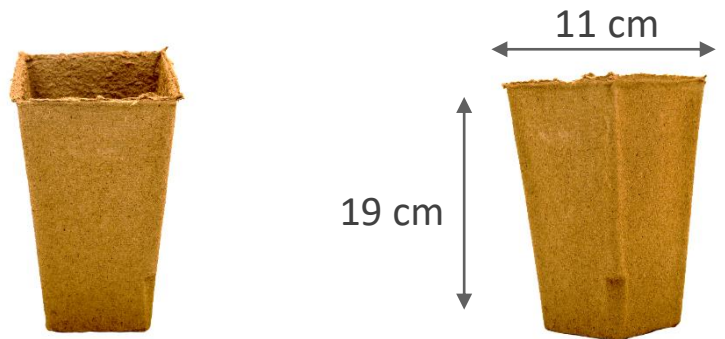

- **FERTILPOT 9.3x5.0**
- **270 cm³**

574.01: Palette de 7 920 pots

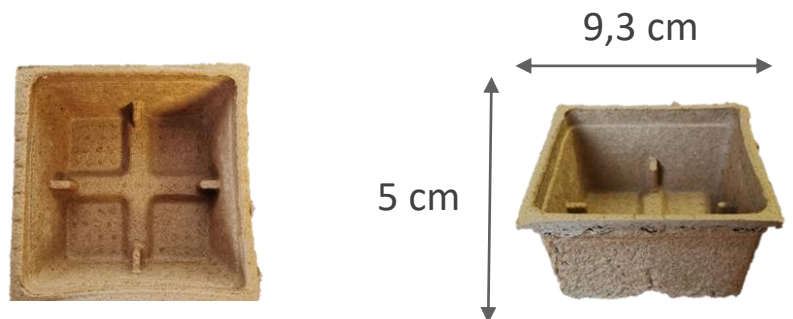

Pots carrés individuels - HC

- **FERTILPOT 4,5x4,5**

- **80 cm³**

5453.HC: Carton de 1 080 pots

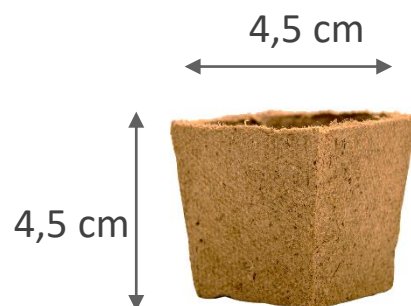

- **FERTILPOT 7,5x7**

- **280 cm³**

552.HC: Carton de 336 pots

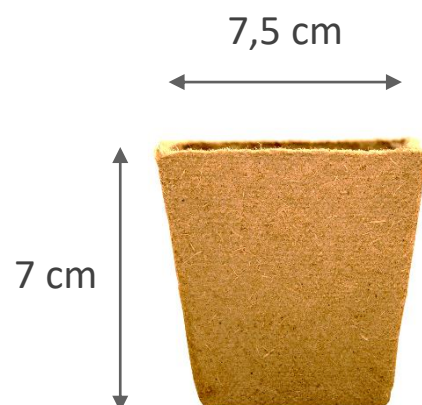

- **FERTILPOT 10x18**

- **1 350 cm³**

571N.HC: Carton de 180 pots

571N.H: Palette de 3 696 pots

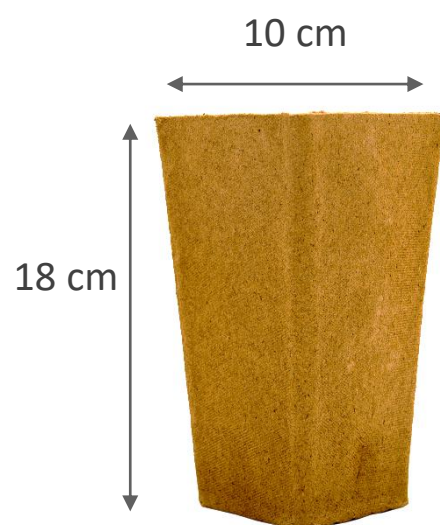

FERTILPOT en plaque

- **FERTILPOT 4x5 – 36 pots**

- **35 cm³**

541.C: Carton de 5 184 pots

541.36: Palette de 76 032 pots

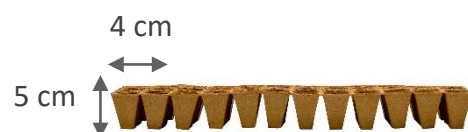

3 x 12 pots

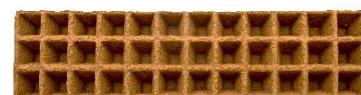

- **FERTILPOT 4,4x4,3 – 33 pots**

- **30 cm³**

543.C: Carton de 4 026 pots

543.33: Palette de 76 032 pots



3 x 11 pots



- **FERTILPOT 5x5 – 30 pots**

- **55 cm³**

544.C: Carton de 3 900 pots

544.30: Palette de 52 800 pots



3 x 10 pots

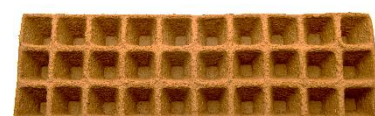

- **FERTILPOT 5x5 – 20 pots**

- **90 cm³**

545.C: Carton de 1 740 pots

545.20: Palette de 30 160 pots



2 x 10 pots



FERTILPOT en plaque

- **FERTILPOT 5x5 – 30 pots**
- **90 cm³**

5453.C : Carton de 1 740 pots
5453.30: Palette de 31 680 pots



3 x 10 pots



- **FERTILPOT 6x6 – 16 pots**
- **110 cm³**

546.C: Carton de 2 544 pots
546.16: Palette de 33 920 pots



2 x 8 pots



- **FERTILPOT 5,8x6 – 18 pots**
- **110 cm³**

548.C: Carton de 1 998 pots
548.18: Palette de 26 640 pots



2 x 9 pots



- **FERTILPOT 8x8 – 12 pots**
- **300 cm³**

552.C: Carton de 768 pots
552.12: Palette de 12 288 pots



2 x 6 pots



FERTILPOT en plaque

- FERTILPOT 11x19 – 6 pots
- 1450 cm³

571N.06: Palette de 2 268 pots

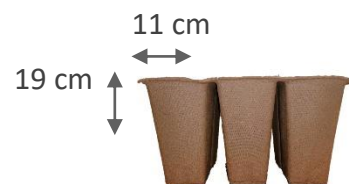

2 x 3 pots



- FERTILPOT 9.3x5.0 – 4 pots
- 270 cm³

574.C: Carton de 416 pots
574.04: Palette de 7 920 pots



2 x 2 pots



- FERTILPOT 5x11 – 77 pots
- 110 cm³

565N.77: Palette de 16 632 pots



7 x 11 pots

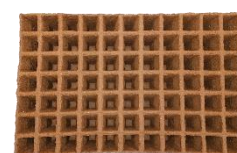

- FERTILPOT 5x7 – 77 pots
- 80 cm³

564.77: Palette de 29 568 pots

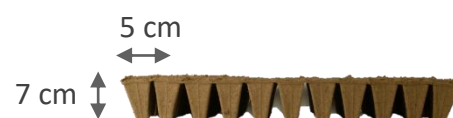

7 x 11 pots

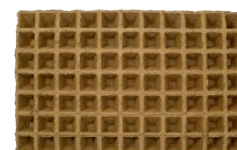

FERTILPOT en plaque

- FERTILPOT 5x5 – 77 pots
- 70 cm³

573.77: Palette de 33 264 pots

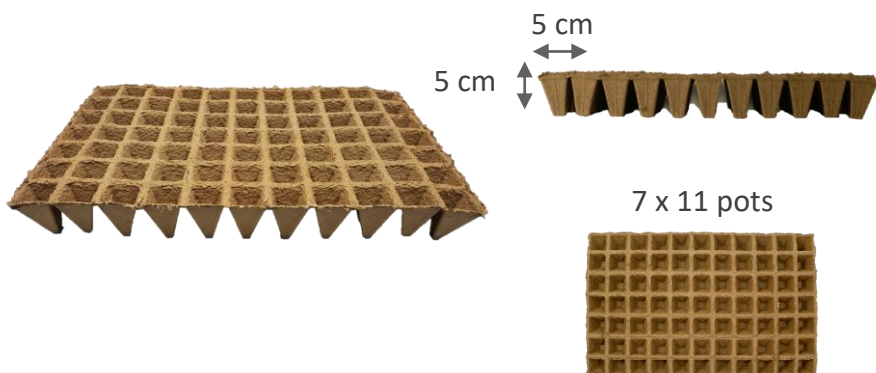

Le sciage des plaques

Toutes les plaques de pots chez FERTIL peuvent être sciées dans la longueur et/ou dans la largeur.

Selon les modèles, une quantité minimum sera demandée. Contactez nous pour plus d'information.

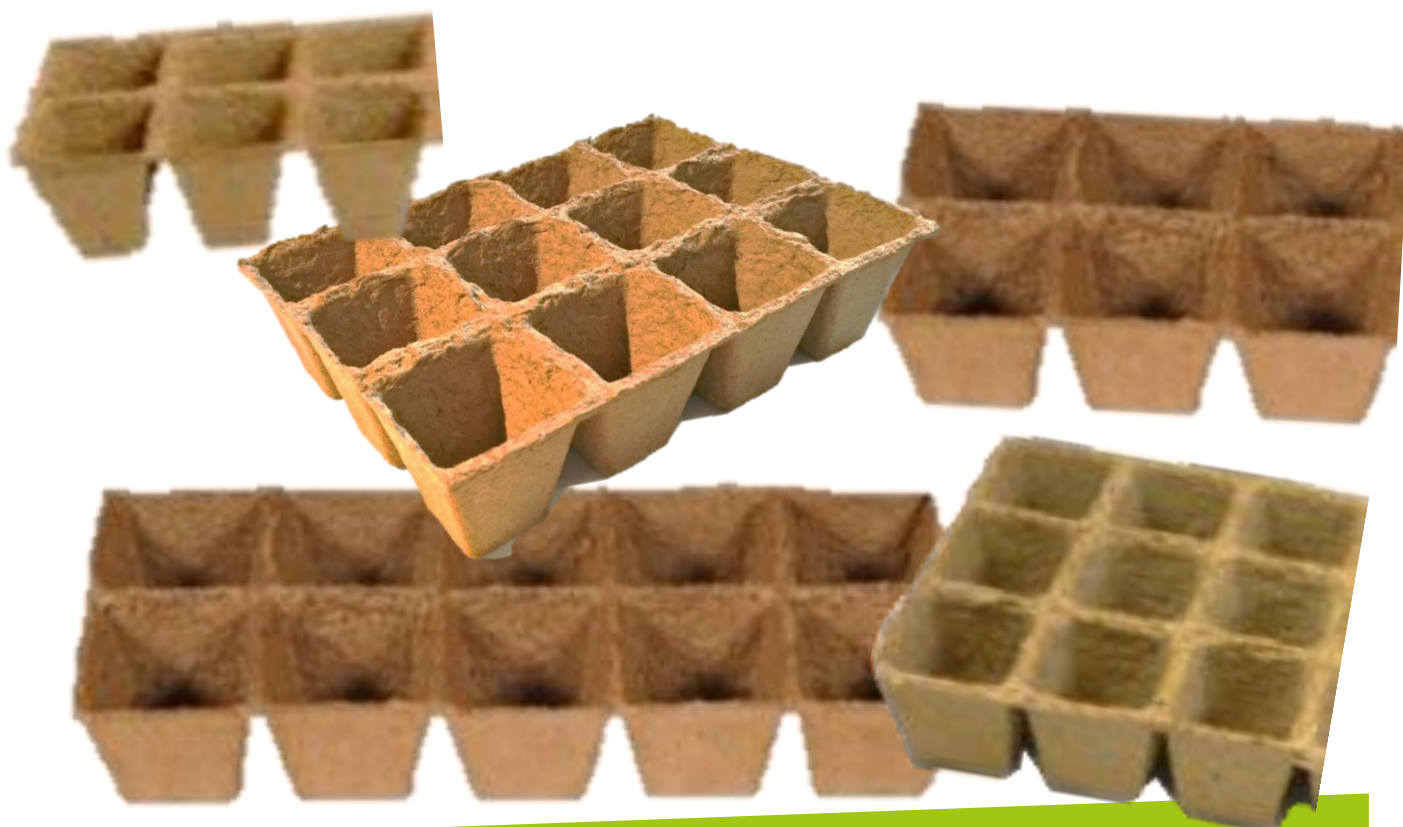
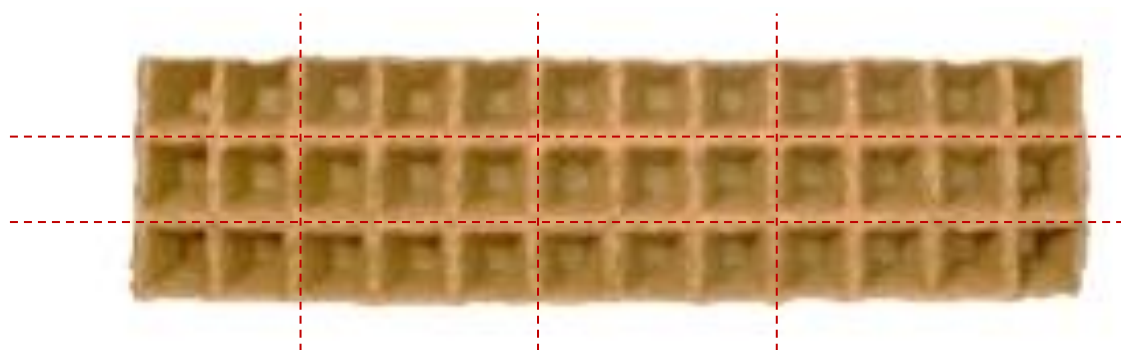

La gamme FERTILPACK

- **FERTILPACK 77 alvéoles**
- **Fertilpot : 4,5 x 6,5 (cm)**

564.T77C: Carton de 1 001 pots

564.T77: Palette de 21 175 pots



- **FERTILPACK 32 alvéoles**
- **Fertilpot : 7 x 9 (cm)**

509.TE32: Palette de 8 064 pots

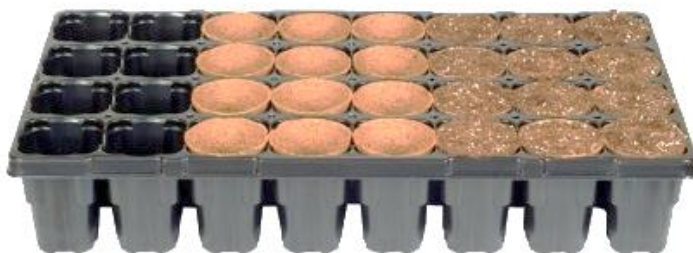

- **FERTILPACK 20 alvéoles**
- **Fertilpot : 8 x 8 (cm)**

510.TE20: Palette de 7 200 pots





Service commercial
38 rue de Bellevue
92100 Boulogne Billancourt
+33 (0)1 46 04 41 24
adv@fertil.fr

**VALORISONS ENSEMBLE
UN VÉGÉTAL RESPONSABLE**